

Article number: 03442045

Description: Fluro Rod end GE 45EC-NIRO

Measures

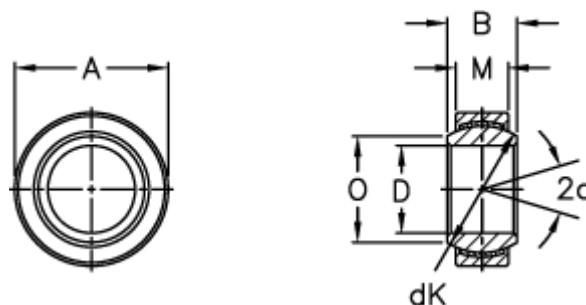

A	= 68 0 -0,013	Tilt angle = 7
B	= 32	Weight = 400
D	= 45 0 -0,012	
dK	= 60	
Dynamic load C (kN)	= 247	
M	= 25	
O	= 50.8	
Static load C0 (kN)	= 481	